

Extension Locks

Medeco® offers a threaded extension lock that can be used in laundry, vending or a variety of other applications. All models feature hardened steel inserts that protect against drilling and other vandal attacks on the cylinder. In addition to excellent protection against physical attack, Medeco features patented key control and pin tumblers that must elevate, rotate and align perfectly with the cylinder's sidebar, giving you double protection against picking.

The Medeco³ unique design provides triple locking action, making the locks virtually pickproof. All Medeco³ keys and locks are protected under patent trademark and copyright laws. Medeco³ keys may only be duplicated by Medeco or an authorized Medeco Service Center, and only at your request.



Benefits:

- ▼ Patented Medeco³ keys may only be duplicated by Medeco or an authorized Medeco Service Center, and only at your request.
- ▼ Special angle cut keys are patent protected to guard against unauthorized duplication.
- ▼ Supported by factory trained service outlets.
- ▼ Unique elevating and rotating pin tumbler system is virtually pick proof

Applications:

Medeco's threaded extension and rotary locks can be used in laundry, vending or a variety of other applications.

Certification:

UL® Listed

Warranty:

Warranted for two years against manufacturer's defects. See Medeco Limited Warranty for full details.

Technical Information:

Four and five pin models available depending on size.
Available with a rotary t or threaded extension
5/16" - 24 thread
5/16" - 18 thread
Various lengths

Finishes:

26 Satin Chrome finish standard.

Ordering Instructions - Threaded Extension Locks

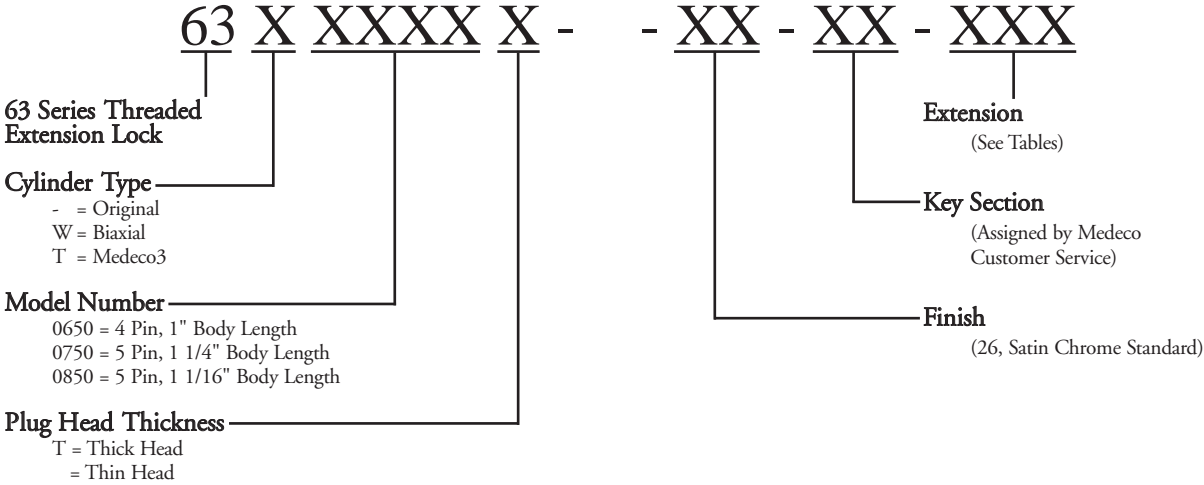

Technical Drawing

THREADED EXTENSION LOCKS

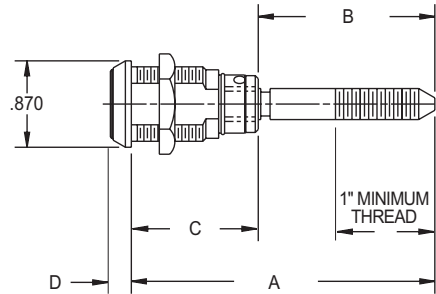
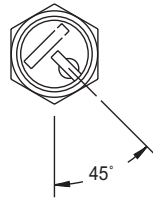

63X0650 X, 4 Pin Threaded Extension Lock

Extension	A (Decimal)	A (Fraction)	Thread	B	C	D
M26	1.500	1 1/2"	5/16-24	0.473	1.027	0.265
M35	1.562	1 9/16"	5/16-18	0.535	1.027	0.265
M12	1.802	1 13/16"	5/16-18	0.775	1.027	0.265
M14	1.989	2"	5/16-18	0.962	1.027	0.265
M22	2.187	2 3/16"	5/16-18	1.160	1.027	0.265
M27	2.249	2 1/4"	5/16-18	1.222	1.027	0.265
M18	2.747	2 3/4"	5/16-18	1.720	1.027	0.265
M01	2.805	2 13/16"	5/16-18	1.778	1.027	0.265
M03	2.864	2 7/8"	5/16-18	1.837	1.027	0.265
M28	2.874	2 7/8"	5/16-24	1.847	1.027	0.265
M04	2.989	3"	5/16-18	1.962	1.027	0.265
M29	3.124	3 1/8"	5/16-18	2.097	1.027	0.265
M11	3.489	1 1/2"	5/16-24	2.462	1.027	0.265
M21	3.499	1 1/2"	5/16-18	2.472	1.027	0.265
M16	3.615	3 5/8"	5/16-24	2.588	1.027	0.265
M23	3.615	3 5/8"	5/16-18	2.588	1.027	0.265
M20	4.124	4 1/8"	5/16-18	3.097	1.027	0.265
M15	4.489	4 1/2"	5/16-18	3.462	1.027	0.265
M25	4.677	4 11/16"	5/16-24	3.650	1.027	0.265
M24	4.749	4 3/4"	5/16/18	3.722	1.027	0.265
M07	4.864	4 7/8"	5/16-18	3.837	1.027	0.265
M31	5.125	5 1/8"	5/16-18	4.098	1.027	0.265
M32	5.250	5 1/4"	5/16-18	4.223	1.027	0.265
M37	5.375	5 3/8"	5/16-18	4.348	1.027	0.265
M09	5.739	5 3/4"	5/16-18	4.712	1.027	0.265
M17	6.124	6 1/8"	5/16-18	5.097	1.027	0.265
M30	6.249	6 1/4"	5/16-18	5.222	1.027	0.265
M36	7.000	7"	5/16-18	5.973	1.027	0.265
M05	7.427	7 7/16"	5/16-18	6.400	1.027	0.265
M33	7.427	7 7/16"	5/16-24	6.400	1.027	0.265
M06	7.989	8"	5/16-18	6.962	1.027	0.265
M08	8.239	8 1/4"	5/16-18	7.212	1.027	0.265
M02	8.489	8 1/2"	5/16-18	7.462	1.027	0.265
M10	8.739	8 3/4"	5/16-18	7.712	1.027	0.265
M13	14.864	14 7/8"	5/16-18	13.837	1.027	0.265
M34	14.864	14 7/8"	5/16-24	13.837	1.027	0.265

Technical Drawing

THREADED EXTENSION LOCKS

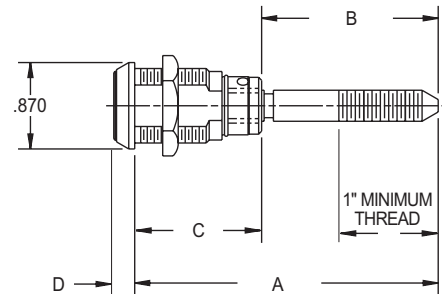
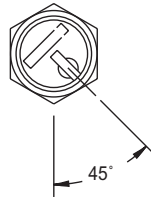

63X0750 X, 5 Pin Threaded Extension Lock

Extension	A (Decimal)	A (Fraction)	Thread	B	C	D
M26	1.751	1 3/4"	5/16-24	0.473	1.278	0.183
M35	1.813	1 13/16"	5/16-18	0.535	1.278	0.183
M12	2.053	2 1/16"	5/16-18	0.775	1.278	0.183
M14	2.240	2 1/4"	5/16-18	0.962	1.278	0.183
M22	2.438	2 7/16"	5/16-18	1.160	1.278	0.183
M27	2.500	2 1/2"	5/16-18	1.222	1.278	0.183
M18	2.998	3"	5/16-18	1.720	1.278	0.183
M01	3.056	3 1/16"	5/16-18	1.778	1.278	0.183
M03	3.115	3 1/8"	5/16-18	1.837	1.278	0.183
M28	3.125	3 1/8"	5/16-24	1.847	1.278	0.183
M04	3.240	3 1/4"	5/16-18	1.962	1.278	0.183
M29	3.385	3 3/8"	5/16-18	2.107	1.278	0.183
M11	3.740	3 3/4"	5/16-24	2.462	1.278	0.183
M21	3.750	3 3/4"	5/16-18	2.472	1.278	0.183
M16	3.866	3 7/8"	5/16-24	2.588	1.278	0.183
M23	3.866	3 7/8"	5/16-18	2.588	1.278	0.183
M20	4.375	4 3/8"	5/16-18	3.097	1.278	0.183
M15	4.740	4 3/4"	5/16-18	3.462	1.278	0.183
M25	4.928	4 15/16"	5/16-24	3.650	1.278	0.183
M24	5.000	5"	5/16-18	3.722	1.278	0.183
M07	5.115	5 1/8"	5/16-18	3.837	1.278	0.183
M31	5.376	5 3/8"	5/16-18	4.098	1.278	0.183
M32	5.501	5 1/2"	5/16-18	4.223	1.278	0.183
M37	5.626	5 5/8"	5/16-18	4.348	1.278	0.183
M09	5.990	6"	5/16-18	4.712	1.278	0.183
M17	6.375	6 3/8"	5/16-18	5.097	1.278	0.183
M30	6.500	6 1/2"	5/16-18	5.222	1.278	0.183
M36	7.251	7 1/4"	5/16-18	5.973	1.278	0.183
M05	7.672	7 11/16"	5/16-18	6.394	1.278	0.183
M33	7.678	7 11/16"	5/16-24	6.400	1.278	0.183
M06	8.240	8 1/4"	5/16-18	6.962	1.278	0.183
M08	8.490	8 1/2"	5/16-18	7.212	1.278	0.183
M02	8.740	8 3/4"	5/16-18	7.462	1.278	0.183
M10	8.900	9"	5/16-18	7.712	1.278	0.183
M13	15.115	15 1/8"	5/16-18	13.837	1.278	0.183
M34	15.115	15 1/8"	5/16-24	13.837	1.278	0.183

Technical Drawing

THREADED EXTENSION LOCKS

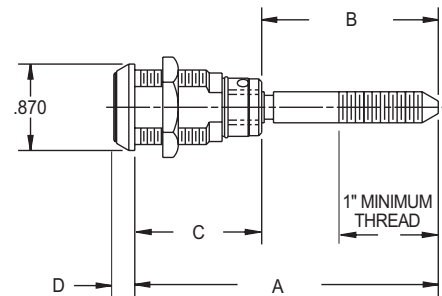
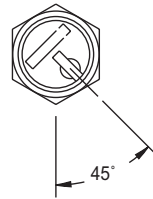

63X0850 X, 5 Pin Threaded Extension Lock

Extension	A (Decimal)	A (Fraction)	Thread	B	C	D
M26	1.561	1 9/16"	5/16-24	0.473	1.088	0.373
M19	1.562	1 9/16"	5/16-18	0.474	1.088	0.373
M35	1.623	1 5/8"	5/16-18	0.535	1.088	0.373
M12	1.863	1 7/8"	5/16-18	0.775	1.088	0.373
M14	2.050	2 1/16"	5/16-18	0.962	1.088	0.373
M22	2.248	2 1/4"	5/16-18	1.160	1.088	0.373
M27	2.310	2 5/16"	5/16-18	1.222	1.088	0.373
M18	2.808	2 13/16"	5/16-18	1.720	1.088	0.373
M01	2.886	2 7/8"	5/16-18	1.798	1.088	0.373
M03	2.925	2 15/16"	5/16-18	1.837	1.088	0.373
M28	2.935	2 15/16"	5/16-24	1.847	1.088	0.373
M04	3.050	3 1/16"	5/16-18	1.962	1.088	0.373
M29	3.185	3 1/16"	5/16-18	2.097	1.088	0.373
M11	3.550	3 9/16"	5/16-24	2.462	1.088	0.373
M21	3.560	3 9/16"	5/16-18	2.472	1.088	0.373
M16	3.676	3 11/16"	5/16-24	2.588	1.088	0.373
M23	3.676	3 11/16"	5/16-18	2.588	1.088	0.373
M20	4.185	4 3/16"	5/16-18	3.097	1.088	0.373
M15	4.550	4 9/16"	5/16-18	3.462	1.088	0.373
M25	4.738	4 3/4"	5/16-24	3.650	1.088	0.373
M24	4.810	4 13/16"	5/16-18	3.722	1.088	0.373
M07	4.925	4 15/16"	5/16-18	3.837	1.088	0.373
M31	5.186	5 3/16"	5/16-18	4.098	1.088	0.373
M32	5.311	5 5/16"	5/16-18	4.223	1.088	0.373
M37	5.434	5 7/16"	5/16-18	4.346	1.088	0.373
M09	5.800	5 13/16"	5/16-18	4.712	1.088	0.373
M17	6.185	6 3/16"	5/16-18	5.097	1.088	0.373
M30	6.310	6 5/16"	5/16-18	5.222	1.088	0.373
M36	7.061	7 1/16"	5/16-18	5.973	1.088	0.373
M05	7.488	7 1/2"	5/16-18	6.400	1.088	0.373
M33	7.488	7 1/2"	5/16-24	6.400	1.088	0.373
M06	8.050	8 1/16"	5/16-18	6.962	1.088	0.373
M08	8.300	8 5/16"	5/16-18	7.212	1.088	0.373
M02	8.550	8 9/16"	5/16-18	7.462	1.088	0.373
M10	8.800	8 13/16"	5/16-18	7.712	1.088	0.373
M13	14.925	14 15/16"	5/16-18	13.837	1.088	0.373
M34	14.925	14 15/16"	5/16-24	13.837	1.088	0.373

Ordering Instructions - Rotary T Locks

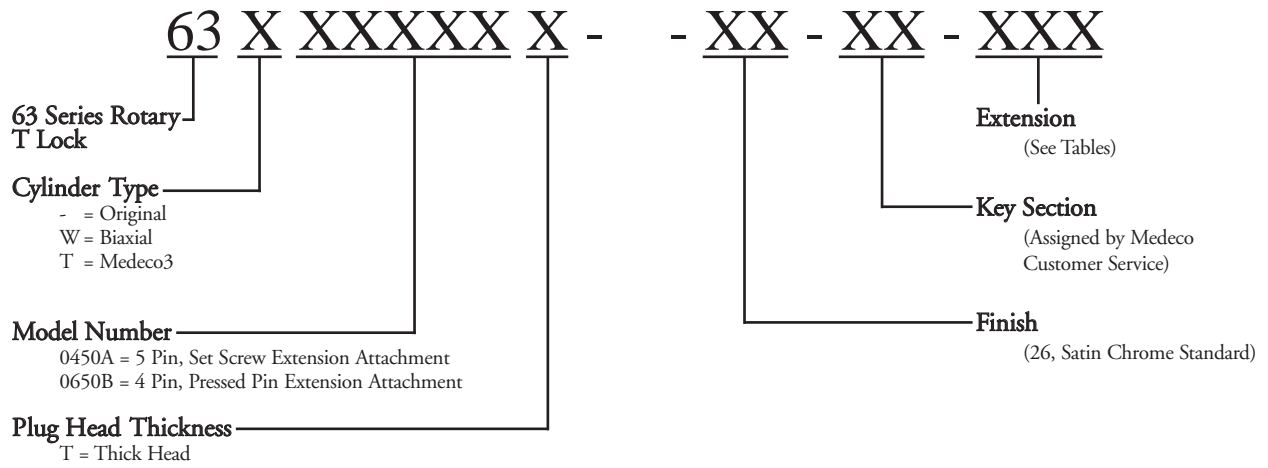

Technical Drawing

ROTARY T LOCKS

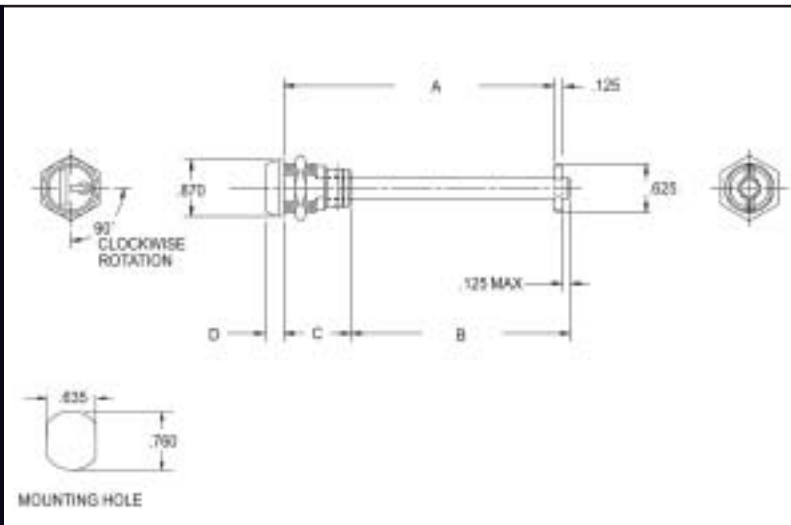

63X0650BX, 4 Pin Rotary T Lock, Pressed Pin Extension Attachment

Extension	A	B	C	D
N26	1.750	.973	1.027	0.265
N64	6.844	6.057	1.027	0.265
N65	9.469	8.962	1.027	0.265
N49	12.670	11.888	1.027	0.265

63X0450AX, 5 Pin Rotary T Lock, Set Screw Extension Attachment

Extension	A	B	C	D
N56	3.000	1.972	1.278	0.183
N50	5.498	4.470	1.278	0.183
N53	7.359	6.331	1.278	0.183
N54	8.940	7.912	1.278	0.183
N52	12.174	11.146	1.278	0.183